

Article number: 03219030

Description: Fluro Rod End GILRSW 30-R

Housing and ball in stainless steel with left-handed thread

Measures

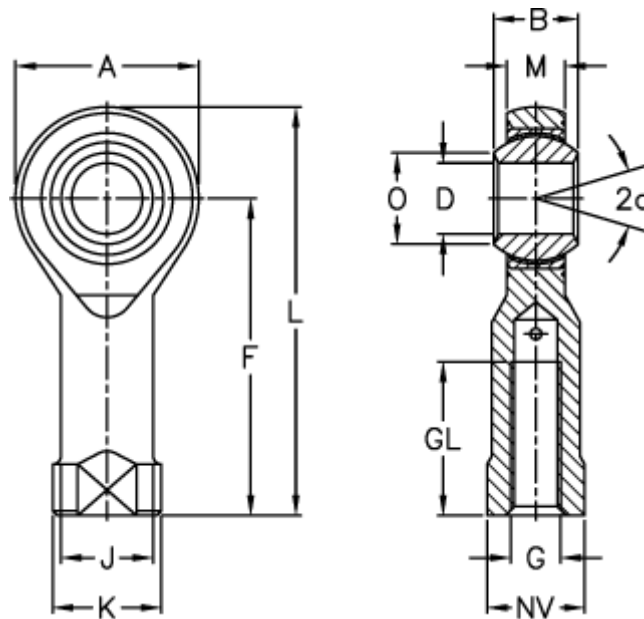

A	= 70	J	= 40	Weight (g) = 1130
a (degrees)	= 17	K	= 50	
B	= 37	L	= 145	
D	= 30	M	= 25	
Dynamic load C (kN)	= 168	NV	= 41	
F	= 110	O	= 34.8	
G	= M30x2	Permissible rpm	= 130	
GL	= 51	Static load C0 (kN)	= 155	